

**ESTEVEZ**<sup>®</sup>  
Conectando lo extraordinario



# Extractores

Ventilación



## De pared

### Serie 1000

#### Económico Cuadrado

Extractor de aire / Blanco / 5 años de garantía.  
\*Instalar el reductor puede disminuir el flujo de aire.



Código	Ducto	Montaje	Ruido	Dimensiones A B	Flujo de aire	Consumo
1004 (eco)	4"	Instalación en muro o ventana	41dB	150*150mm	43 CFM	15W 127V~ 60Hz
1005 (eco)	5"		41dB	182*182mm	79.4 CFM	17W 127V~ 60Hz
1006 (eco)	6"		48dB	209*209mm	130 CFM	25W 127V~ 60Hz

Accesorios: Solo para el modelo 1005 \*Reductor de 5"a 4" (no incluido)

## Serie 1100

### Cuadrado

Extractor de aire / Blanco / 5 años de garantía.  
\*Instalar el reductor puede disminuir el flujo de aire.

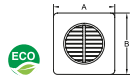

Código	Ducto	Montaje	Ruido	Dimensiones A B	Flujo de aire	Consumo
1104 (eco)	4"	Instalación en muro	41dB	150*150mm	40 CFM	15W 127V~ 60Hz
1106 (eco)	6"		48dB	209*209mm	130 CFM	25W 127V~ 60Hz

Accesorios: 1104/1106 Cable, clavija y contra

## Serie 1200-BL

### Ultra Delgado

Extractor de aire / Blanco / 5 años de garantía / Extra largo.

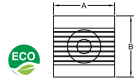

Código	Ducto	Montaje	Ruido	Dimensiones A B	Flujo de aire	Consumo
1204-BL (eco)	4"	Instalación en muro	39dB	150*150mm	57 CFM	15W 127V~ 60Hz
1205-BL (eco)	5"		43dB	182*182mm	54 CFM	17W 127V~ 60Hz
1206-BL (eco)	6"		46dB	208*208mm	111 CFM	25W 127V~ 60Hz

Accesorios: 1204 BL/ 1206 BL Cable, clavija contra y rejilla trasera de apertura automática  
1205 BL: Cable, clavija contra, reductor 5" - 4" y rejilla trasera de apertura automática

## Serie 1300-BL

### Tipo Europeo

Extractor de aire / Blanco / 5 años de garantía.

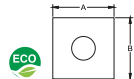

Código	Ducto	Montaje	Ruido	Dimensiones A B	Flujo de aire	Consumo
1304-BL (eco)	4"	Instalación en muro	41dB	150*150mm	31.2 CFM	17W 127V~ 60Hz
1306-BL (eco)	6"		46dB	209*209mm	56.5 CFM	27W 127V~ 60Hz

## Serie 1300-INOX

### Tipo Europeo



Extractor de aire / Blanco / 5 años de garantía.



Código	Ducto	Montaje	Ruido	Dimensiones	Flujo de aire	Consumo
1304-INOX (eco)	4"	Instalación en muro	41dB	150*150mm <small>A B</small>	31.2 CFM	17W 127V~ 60Hz
1306-INOX (eco)	6"		43dB	209*209mm	56.5 CFM	20W 127V~ 60Hz

## Serie 1500

### Extractor Redondo con Cordón

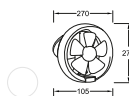

Extractor de Aire para ventana.



Código	Ducto	Montaje	Ruido	Dimensiones	Flujo de aire	Consumo
1508 (eco)	8"	Instalación en ventana	48dB	270*270* 105 mm	121 CFM	25W 127V~ 60Hz

## Serie 2100

### Super Delgado

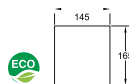

Extractor de aire / Blanco, Rojo / 5 años de garantía.



Código	Ducto	Montaje	Ruido	Dimensiones	Flujo de aire	Consumo
2104-RJ (eco)	4"	Instalación en muro	42dB	145*165mm	28.2 CFM	17W 127V~ 60Hz
2104-BL (eco)						

Accesorios: Contra

## Serie 2300

### Tipo Australiano



Extractor de aire / Blanco, Acero inoxidable / 5 años de garantía.



Código	Ducto	Montaje	Ruido	Dimensiones	Flujo de aire	Consumo
2304-BL (eco)	4"	Instalación en muro	40dB	150*150mm	41.8 CFM	15W 127V~ 60Hz
2304-INOX (eco)						

Accesorios: Contra

## Serie 2400-UB

### Económico Ultra Blanco



Extractor de aire / Ultra Blanco / 5 años de garantía.



Código	Ducto	Montaje	Ruido	Dimensiones	Flujo de aire	Consumo
2404-UB (eco)	4"	Instalación en muro	33dB	160*160mm	71 CFM	15W 127V~ 60Hz

## Serie 2500 Tipo Palma



Extractor de aire / Blanco.



Código	Ducto	Montaje	Ruido	Dimensiones A B	Flujo de aire	Consumo
2504	4"	Instalación en muro o techo	40dB	150*120mm	45 CFM	11W 127V~ 60Hz
2506	6"		44dB	205*165mm	162 CFM	33W 127V~ 60Hz

Accesorios: Rejilla frontal y persiana trasera

## Serie 2600 Tipo Japonés



Extractor de aire / Blanco.



Código	Ducto	Montaje	Ruido	Dimensiones A B	Flujo de aire	Consumo
2604	4"	Instalación en pared	40dB	165*150mm	45 CFM	11W 127V~ 60Hz
2606	6"		45dB	212*195mm	162 CFM	34W 127V~ 60Hz

Accesorios: Rejilla frontal y persiana trasera

## Serie 2700 Tipo Francés



Extractor de aire / Blanco.



Código	Ducto	Montaje	Ruido	Dimensiones A B	Flujo de aire	Consumo
2704	4"	Instalación en pared	39dB	152*120mm	42 CFM	11W 127V~ 60Hz
2706	6"		45dB	205*165mm	159 CFM	34W 127V~ 60Hz

Accesorios: Persiana trasera

## Serie 2800 Tipo Inglés



Extractor de aire / Blanco.



Código	Ducto	Montaje	Ruido	Dimensiones A B	Flujo de aire	Consumo
2804	4"	Instalación en pared	40dB	159*135mm	43 CFM	11W 127V~ 60Hz
2806	6"		45dB	206*182mm	169 CFM	33W 127V~ 60Hz

Accesorios: Persiana trasera

## Serie 2900 Cristal



Extractor de aire / Cristal negro / 5 años de garantía.



Código	Ducto	Montaje	Ruido	Dimensiones A B	Flujo de aire	Consumo
2904-CN	4"	Instalación en muro	33dB	170*170mm	51.8 CFM	14W (motor) 127V~ 60Hz

## Serie 3000 Eco



Extractor de Aire con sensor de humedad y Termómetro ambiental.

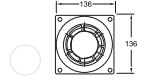

Código	Ducto	Montaje	Ruido	Dimensiones	Flujo de aire	Consumo
3004-BL	4"	Instalación en muro	33dB	136*136mm	56 CFM	14W 127V~60Hz

## Serie 2200 iColors



Extractor de aire / Rojo, Azul, Negro, Verde, Titanio/ 5 años de garantía.



Código	Ducto	Montaje	Ruido	Dimensiones	Flujo de aire	Consumo
2204-VD (eco)	4"	Instalación en muro	42dB	150*140mm	33.5 CFM	17W 127V~60Hz
2204-RJ (eco)						
2204-TT (eco)						
2204-AZ (eco)						
2204-NG (eco)						

## De pared Mix & Match

### Serie 2200 iColors



Extractor de aire iColors / Contiene 5 carátulas de diferente color.



Código	Ducto	Montaje	Ruido	Dimensiones	Flujo de aire	Consumo
2204-51 (eco)	4"	Instalación en muro	42dB	150*140* 93 mm	33 CFM	17W 127V~60Hz

## Serie 3100

### Extractor sin Tapa Mix & Match



Extractor de Aire Cuadrado sin Tapa

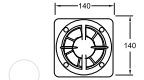

Código	Ducto	Montaje	Ruido	Dimensiones	Flujo de aire	Consumo
3104	4"	Instalación en muro	34dB	101*140* 140mm	56 CFM	11W 127V~60Hz

## Carátulas frontales Mix&Match



Código	Montaje	Dimensiones	Material	Acabado	
3104-TBL	Compatible con Ducto de 4"	Sobre la parte frontal del extractor	160*160mm	ABS	Blanco
3104-TNZ				ABS / Aluminio	Negro Zafiro
3104-TCR			160*160mm	ABS / Cristal	Cromo
3104-TCB					Cristal Blanco
3106-TMS Mystery		180*180mm	ABS	Blanco	

## Personaliza tu extractor

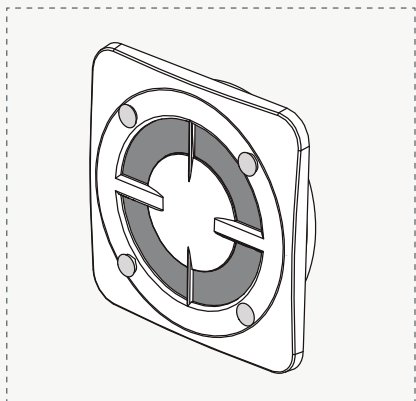

**1**

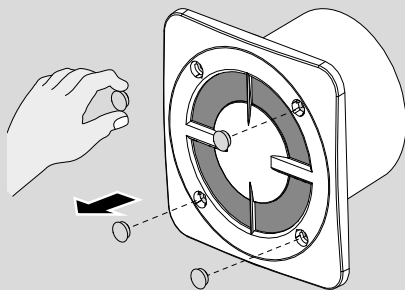

**2**

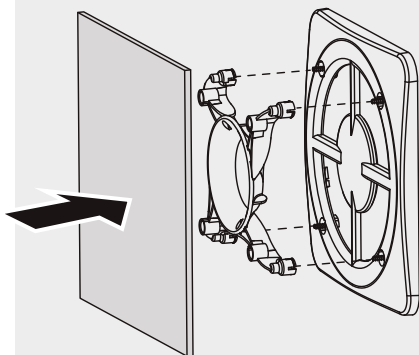

**3**

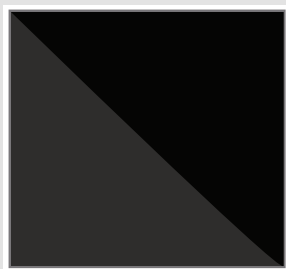

Carátula y motor

**4**

## De pared con funciones

### Serie 1100-M

con Sensor de Movimiento



Extractor de aire / Blanco / 5 años de garantía.



Código	Ducto	Montaje	Ruido	Dimensiones	Flujo de aire	Consumo
1104-M(eco)	4"	Instalación en muro o ventana	41dB	150*150mm	40 CFM	15W 127V~ 60Hz

Accesorios: Sensor de movimiento, cable, clavija y contra

### Serie 1204-BL-T

con Temporizador

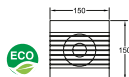

Extractor de aire / Blanco.



Código	Ducto	Montaje	Ruido	Dimensiones	Flujo de aire	Consumo
1204-BL-T (eco)	4"	Instalación en muro	39dB	150*150mm	56.5 CFM	15W 127V~ 60Hz

### Serie 1400-H

con Sensor de Humedad

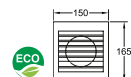

Extractor de aire / Blanco.



Código	Ducto	Montaje	Ruido	Dimensiones	Flujo de aire	Consumo
1404-H (eco)	4"	Instalación en muro o ventana	35dB	150*165mm	37.6 CFM	15W 127V~ 60Hz

Accesorios: Sensor de humedad y Rejilla frontal de apertura automática

### Serie 3204

Digital

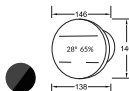

Extractor de Aire con Sensor de Humedad, Temporizador y Display.



Código	Ducto	Montaje	Ruido	Dimensiones	Flujo de aire	Consumo
3204-HTD (eco)	8"	Instalación en ventana / techo / muro	34dB	146*138* 146 mm	46 CFM	11W 127V~ 60Hz

Accesorios: Termómetro ambiental

### Serie 3800

Tic Tac



Extractor de aire / Blanco.



Código	Ducto	Montaje	Ruido	Dimensiones	Flujo de aire	Consumo
3804	4"	Instalación en muro	39dB	150*120mm	42 CFM	11W 127V~ 60Hz

Accesorios: Reloj y persiana trasera



## De techo

### Serie 1600

#### Tipo Americano



Extractor de aire / Blanco / 5 años de garantía.



Código	Ducto	Montaje	Ruido	Dimensiones	Flujo de aire	Consumo
1604(eco)	4"	Instalación en plafón	40dB	260*260mm	62.9 CFM	22W 127V~ 60Hz

Accesorios Cable, clavija y rejilla trasera de apertura automática

## Serie 2000

### Extractor con Luz



Extractor de aire / Blanco / 5 años de garantía.

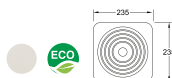

Código	Ducto	Montaje	Ruido	Dimensiones	Flujo de aire	Consumo
2004-BL (eco)	4"	Instalación en plafón	42dB	235*235mm	62.9 CFM	22 W motor 127 V~ 60 Hz Luz 5 W

Accesorios: Luz LED incluida

## Serie 3300

### Extractor de Aire silencioso para Techo

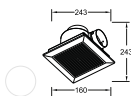

Código	Ducto	Montaje	Ruido	Dimensiones	Flujo de aire	Consumo
3304	4"	Instalación en techo	28dB	243*243* 160 mm	64 CFM	19W 127V~ 60Hz

## Serie 3400

### Extractor de Aire silencioso con Luz para Techo



Código	Ducto	Montaje	Ruido	Dimensiones	Flujo de aire	Consumo
3404	4"	Instalación en techo	38dB	272*272* 170 mm	89 CFM	26W motor Luz 10 W 127V~ 60Hz

## Saturn

### Extractor con Luz



Extractor de aire / Bronce imperial / 5 años de garantía.



Código	Ducto	Montaje	Ruido	Dimensiones	Flujo de aire	Consumo
90058	4"	Instalación en plafón	50dB	213*198* 165mm	80 CFM	25W (motor) 127V~ 60Hz

Accesorios: Lámparas incluidas: 2x60W A15

## Millenium

### Extractor con Luz y Luz Piloto



Extractor de aire / Níquel Cepillado, Metaliso / 5 años de garantía / Luz de noche no incluida (1x 7W C7)



Código	Ducto	Montaje	Ruido	Dimensiones	Flujo de aire	Consumo
90067	4"	Instalación en plafón	58dB	246*226*187mm	110 CFM	36W (motor) 127V~ 60Hz

Accesorios Lámparas 1x30W CFL

## Uso Industrial

### Serie 1700

#### Industrial Plástico sin Rejilla

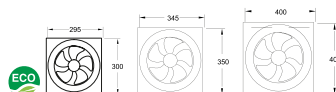

Extractor de aire / Blanco / Industrial / 5 años de garantía.



Código	Ducto	Montaje	Ruido	Dimensiones A B	Flujo de aire	Consumo
1708 (eco)	8"	Instalación en muro o ventana	43dB	295*300mm	322.4 CFM	35W 127V~ 60Hz
1710 (eco)	10"		41dB	345*350mm	452.4 CFM	42W 127V~ 60Hz
1712 (eco)	12"		48dB	400*405mm	597.1 CFM	46W 127V~ 60Hz

Accesorios: Cable, clavija y rejilla trasera de apertura automática

### Serie 1800

#### Industrial Metálico con Rejilla

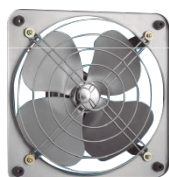
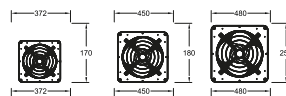

Código	Ducto	Montaje	Ruido	Dimensiones	Flujo de aire	Consumo
1812	12"	Instalación en muro	44dB	372*372*170 mm	702 CFM	51W
1814	14"		52dB	450*450*180 mm	918 CFM	79W
1816	16"		60dB	480*480*250 mm	1065 CFM	106W 127V~ 60Hz

### Serie 1900

#### Industrial Metálico con Rejilla

Extractor de aire / Acero / Fabricado en lámina de acero espesor de 1.0 a 1.2 mm / 5 años de garantía.

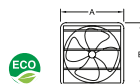

Código	Ducto	Montaje	Ruido	Dimensiones A B	Flujo de aire	Consumo
1910 (eco)	10"	Instalación en muro	49dB	315*315mm	437.1 CFM	42W 127V~ 60Hz
1912 (eco)	12"		52dB	372*372mm	739.4 CFM	51W 127V~ 60Hz
1914 (eco)	14"		55dB	450*450mm	882.4 CFM	79W 127V~ 60Hz

## Uso Comercial

### Serie EVF-IF

Extractor de Aire In Line Axial

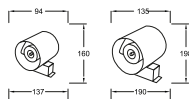

Código	Ducto	Montaje	Ruido	Dimensiones	Flujo de aire	Consumo
EVF-IF4	4"	Instalación en techo	39dB	94*160* 137 mm	42 CFM	17W
EVF-IF6	6"		53dB	135*198* 190 mm	142 CFM	25W 127V~ 60Hz

### Serie EVF-IC

Extractor de Aire In Line Blower Centrífugo Colgante

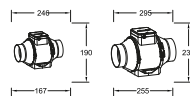

Código	Ducto	Montaje	Ruido	Dimensiones	Flujo de aire	Consumo
EVF-IC4	4"	Instalación en techo	47dB	246*190* 167 mm	92 CFM	24W
EVF-IC6	6"		59dB	295*250* 233 mm	274 CFM	97W 127V~ 60Hz

### Serie EVF-ID

Extractor de Aire In Line Blower Centrífugo Metálico Azul

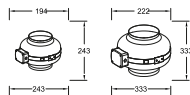

Código	Ducto	Montaje	Ruido	Dimensiones	Flujo de aire	Consumo
EVF-ID4	4"	Instalación en techo	60dB	194*243* 243 mm	162 CFM	92W
EVF-ID6	6"		60dB	222*333* 333 mm	291 CFM	154W 127V~ 60Hz

### Serie EVF-FF1

Extractor de Aire In Line Blower Centrífugo Vertical

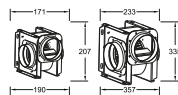

Código	Ducto	Montaje	Ruido	Dimensiones	Flujo de aire	Consumo
EVF-FF1015	4"	Instalación en techo	43dB	171*207* 190 mm	100 CFM	21W
EVF-FF1545	6"		49dB	233*335* 357 mm	250 CFM	75W 127V~ 60Hz

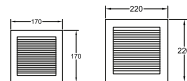
**KDK****Serie KDK**  
Ultra Silencioso

Extractor de aire / Blanco / 5 años de garantía.



Código	Ducto	Montaje	Ruido	Dimensiones	Flujo de aire	Consumo
10EGSA	4"	Instalación en pared	36dB	170*170mm	50 CFM	5.5W
15EGSA	6"		40.5dB	220*220mm	105 CFM	8.8W
						120V~ 60Hz

**Serie KDK**  
Extractor de Aire de Alta presión  
para Montaje en Techo

Código	Frecuencia	Montaje	Ruido	Dimensiones	Flujo de aire	Consumo
24CUH	60Hz	Instalación en techo	32dB	240*240mm	88 CFM	16W 127 V~ 60 Hz
24CHH			39dB		124 CFM	25W 127 V~ 60 Hz



2 velocidades a elegir



Código	Frecuencia	Montaje	Ruido	Dimensiones	Flujo de aire	Consumo
38CHG	60Hz	Instalación en techo	50dB	385*385mm	486 CFM	155.5W 120V~ 60Hz

## Accesorios

### Rejilla Plástica

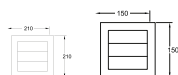

Código	Ducto	Material	Dimensiones	Datos Técnicos
001-4	4"	ABS / Plástico	150*150mm	Instalación en la parte exterior de la pared Incluye: Adaptador para ducto
001-6	6"		210*210mm	

### Rejilla Metálica

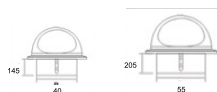

Código	Ducto	Material	Dimensiones	Datos Técnicos
002-4	4"	Metal	145*40mm	Para techo Evita el uso de mufas o codos de PVC, el paso de insectos y que la lluvia baje por el ducto hasta el extractor
002-6	6"		205*55mm	

### Válvula Final Anti-retorno Tipo Check

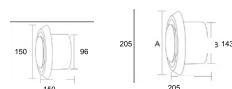

Código	Ducto	Material	Dimensiones	Acabado
003-4	4"	ABS / Plástico	150*96*150mm	Blanco
003-6	6"		205*143*205mm	

### Compuerta para Ducto de Extractor

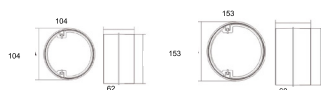

Código	Ducto	Material	Dimensiones	Acabado
004-4	4"	Plástico	104*62*104 mm	Blanco
004-6	6"		153*60*153mm	

### Reductor de 5" a 4"

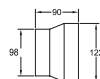

Código	Ducto	Material	Dimensiones	Datos Técnicos
005-4	5"	ABS / Plástico	122*98*90mm	Permite la reducción del ducto del extractor de 5" en instalaciones con salida de 4"

## Válvula Final Anti-retorno de Gravedad

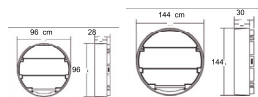

Código	Ducto	Material	Dimensiones	Acabado
006-4	4"	Plástico	96*28*96 mm	Blanco
006-6	6"		144*30*144 mm	

## Rejilla Plástica para Desfogue 90°

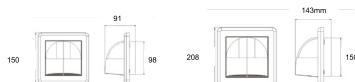

Código	Ducto	Material	Dimensiones	Acabado
007-4	4"	PVC - Metal	150*91*98 mm	Acero
007-6	6"		208*143*150mm	

## Válvula Final Anti-retorno Transparente

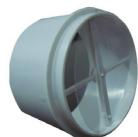
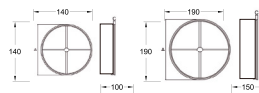

Código	Ducto	Material	Dimensiones	Acabado
008-4	4"	Plástico	102*97*70 mm	Blanco
008-6	6"		148*143*70mm	

## Cambio de Dirección para Ducto de Extractor

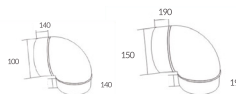

Código	Ducto	Material	Dimensiones	Acabado
090-4	4"	Plástico	140*100*140 mm	Blanco
090-6	6"		190*150*190 mm	





Estévez, S.A. de C.V.  
R.F.C. EST-921022-4Z0  
Av. Niños Héroes 2272  
Col. Barrera, C.P. 44150  
Guadalajara, Jalisco, México

